

DVD Player
DVP 300

Operation Manual



Contents

Safety Precautions	2
Features	3
About Discs	4
Parts Introduction	5
Front Panel	5
Display Panel	6
Rear Panel	6
Remote Control	7
Remote Control Functions	8
Connections	9
Connecting To a TV	9
Connecting To an Analog Amplifier	10
Connecting To an Amplifier With Dolby Digital or DTS Decoder	11
Remote Control Operation	12
System Setup	13
Normal Operation	20
DVD Playback	20
CD Playback	22
MP3 Playback	22
JPEG Playback	23
Playback Functions	24
Troubleshooting	26
Specifications	27

Safety Precautions



WARNING: To reduce the risk of fire or electric shock, **DO NOT** expose this product to rain or moisture.



The lightning flash with arrowhead symbol, within a triangle, alerts the user to “dangerous voltage” which could cause electric shock.



The exclamation point within a triangle indicates to the user to read important operating and maintenance instructions in the manual.

NOTES

1. Read these instructions.
2. Keep these instructions.
3. Heed all warnings.
4. Follow all instructions.
5. Do not use this equipment near water.
6. Clean only with dry cloth.
7. Do not block any ventilation openings or holes. Install according to the manufacturer’s instructions.
8. Do not install near any heat sources such as radiators, heat registers, stoves or other apparatus (including amplifiers) that produces heat.
9. Must be plugged into a polarized or grounding type plug. A polarized plug has two blades with one wider than the other. A grounding type plug has two blades and a third grounding prong. The wide blade or the third prong is provided for your safety. If the provided plug does not fit into your outlet, consult an electrician for replacement of the obsolete outlet.
10. Protect the power cord from being walked on or pinched particularly at plugs, convenience receptacles, and the point where they exit from the machine.
11. Only use attachments/accessories specified by the manufacturer.
12. Use only with the cart, stand, tripod, bracket, or table specified by the manufacturer, or sold with the equipment. When a cart is used, use caution when moving the cart/equipment combination to avoid injury from tip-over.
13. Unplug the equipment during lightning storms or when unused for long periods of time.
14. Refer all servicing to qualified service personnel. Servicing is required when the equipment has been damaged in any way, such as power-supply cord or plug is damaged, liquid has been spilled or objects have fallen into the equipment, exposed to rain or moisture, does not operate normally, or has been dropped.

IMPORTANT FOR LASER PRODUCTS

1. CLASS 1 LASER PRODUCT
2. **DANGER:** Visible laser radiation when open and interlock failed or defeated. Avoid direct exposure to beam.
3. **CAUTION:** Do not open the top cover. There are no user serviceable parts inside the unit, leave all servicing to qualified service personnel.

Features

DUAL COMPATIBILITY

Supports both “Progressive Scan” and “Interlaced” televisions.



IMPORTANT: Ensure the selection switch on the back of the DVD player matches your television type.

HIGH QUALITY PROPERTY

1. High Resolution

Progressive scanning function doubles the vertical resolution of a normal DVD player.

2. Superior Sound

Built-in Dolby AC-3 decoder to output digital audio signal and realize high quality sound effects.

3. Special Function (*)

Support multi-angle and multi-language playback for enjoying unique video features.

4. Complete Range of Output Jacks

Video, S-Video, Y/Pb(Cb)/Pr(Cr), coaxial and 2ch audio out.

5. Video Output

Standard video, S-video and Y/Pb/Pr output. Supports progressive scan signal output.

6. Audio Output

2ch analog audio output and coaxial digital audio output can be connected to any amplifier.

◆ Function with (*) mark only work on a DVD video disc that is compatible with each function.

FEATURES

1. Compatibility

DVD, CD, MP3, CD-R, CD-RW, Picture CD, JPEG compatible.

2. Zoom Function

You can view scenes close-up.

3. All Playback Functions

Fast forward and reverse, slow playback, frame playback, repeat playback and program playback.

4. Search By Time

Can search for the desired content fast by time.

5. Last Memory Playback

In Power ON status, can continue playing your DVD discs from where you stopped last.



6. Parental Control

Control the playback of disc contents with this function.

◆ Supplied Accessories

- L/R Audio cable (x1)
- Composite Video cable (x1)
- Component Video cable (x1)
- Remote control unit (x1)
- AA Batteries (x2)
- User's manual

About Discs

	DISC LOGO	CONTENTS	SIZE	MAXIMUM TIME
DVD		Audio + Video (active picture)	12cm	120min (one side)
				240min (two sides)
			8cm	80min (one side)
				160min (two sides)
CD		Audio	12cm	74min
			8cm	20min
MP3		Audio	12cm	600min

- ◆ The disc manufacturer specifies operation instructions for some DVD discs. Please refer to the instruction manual for details.

NOTES

1. Using of Discs

Do not touch the playing surface of the compact disc.

Do not stick paper or label on the disc.

Do not expose discs to direct sunlight.

Do not place discs near water or in dusty areas.

2. Cleaning of Discs

If a disc has fingerprints or is dusty, lightly wipe the disc with soft cloth (or similar) from the center of the disc outward in a radial manner.

Never use record cleaning sprays, benzene, thinner, static electricity prevention liquids or any other solvents to clean your discs.



This product incorporates copyright protection technology that is protected by method claims of certain U.S. patents and other intellectual property rights owned by Macrovision Corporation and other rights owners. Use of this copyright protection technology must be authorized by Macrovision Corporation, and is intended for home and other limited viewing uses only unless otherwise authorized by Macrovision Corporation. Reverse engineering or disassembly is prohibited.

Parts Introduction

Front Panel

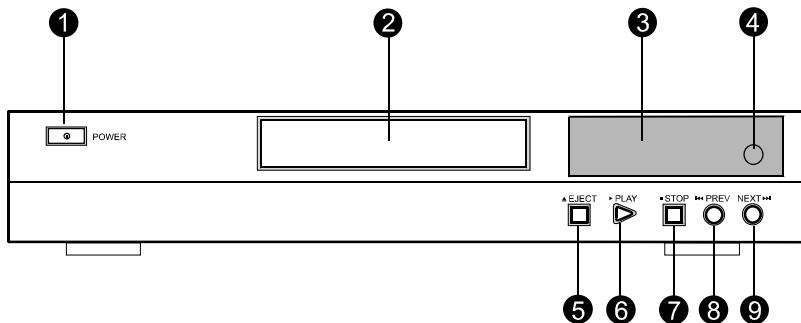

- 1. POWER button**
-Press to turn on/off the power.
- 2. Disc tray**
-Used to load disc
- 2. Display panel**
-Indicates the current status of the unit.
- 4. Remote sensor**
-Receiving the signal from the remote control.
- 5. EJECT button**
-Press to open/close the disc tray.
- 6. PLAY button**
-Press to begin the playback of the inserted disc.
- 7. STOP button**
-Press to stop playback.
- 8. PREV button**
-Press to select previous track/chapter or menu.
- 9. NEXT button**
-Press to select track/chapter or menu.

Parts Introduction

Display Panel

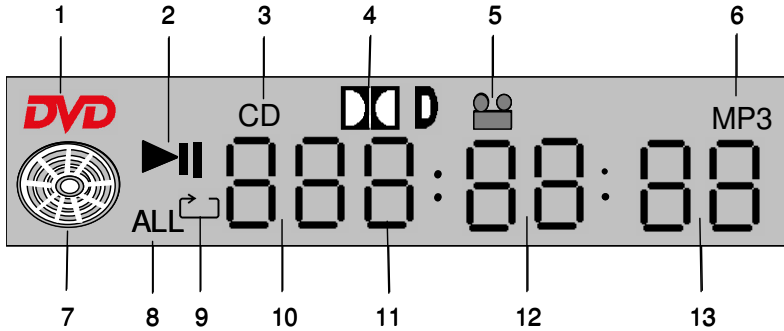

- | | |
|--|--|
| <ol style="list-style-type: none"> 1. DVD disc indicator 2. Playing/pause status indicator 3. CD disc indicator 4. Dolby double-D mark indicator 5. Angle indicator (for DVD discs with multi-angle) 6. MP3 disc indicator 7. Reading status indicator 8. Disc playback status indicator | <ol style="list-style-type: none"> 4. S-Video Output jack 9. Repeat status indicator 10. Chapter number indicator for DVD discs;
Track number indicator for CD discs 11. Hour indicator for playing time 12. Minute indicator for playing time 13. Second indicator for playing time |
|--|--|

Rear Panel

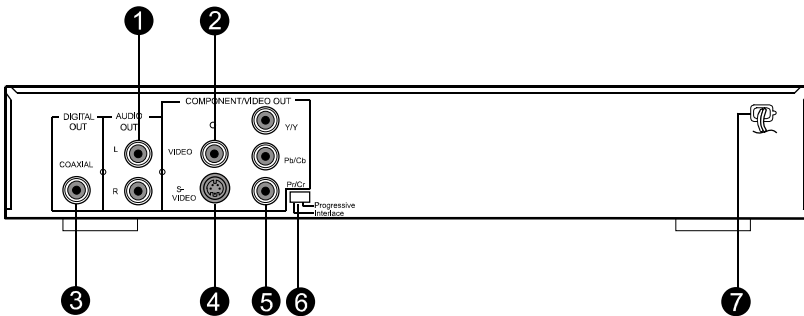

- | | |
|---|--|
| <ol style="list-style-type: none"> 1. Audio Output jacks 2. Video Output jack 3. Coaxial Digital Output jack | <ol style="list-style-type: none"> 5. Component Video Output jacks 6. Switch between "Interlace" and "Progressive" |
|---|--|

Remote Control

- 1. Power
- 2. Angle
- 3. Audio
- 4. Numeric buttons
- 5. +10 button
- 6. Menu
- 7. Navigation buttons
- 8. Setup
- 9. Pause/Step
- 10. Reverse
- 11. Forward
- 12. Program
- 13. Slow
- 14. Display
- 15. Eject
- 16. Subtitle On/Off
- 17. Subtitle
- 18. Search
- 19. Title
- 20. Zoom
- 21. Stop
- 22. Play
- 23. Next Skip/Scan
- 24. Previous Skip/Scan
- 25. Repeat
- 26. A-B Repeat
- 27. Volume Up/Down

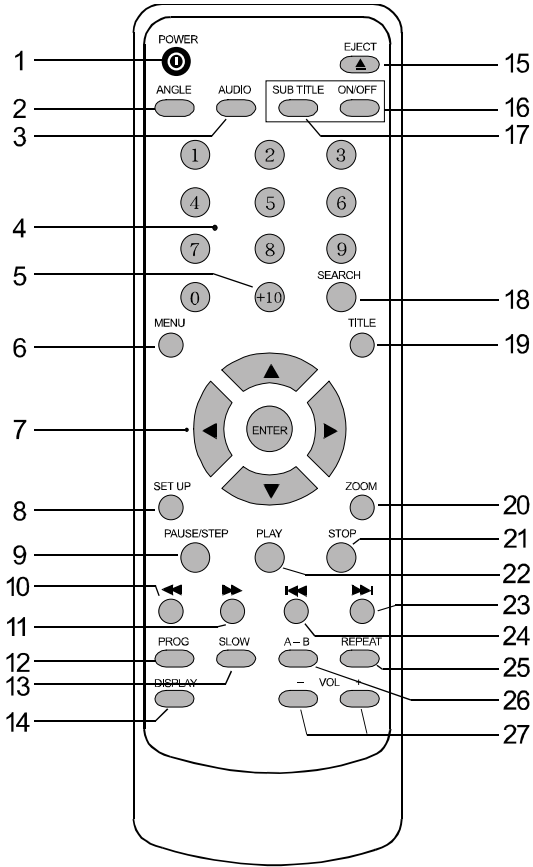

Remote Control Functions

1. **Power** -Press to turn the DVD player on or off.
2. **Angle** -Press to access various camera angles (if the DVD disc contains multiple camera angles).
3. **Audio** -Press to access various audio languages (if the DVD disc contains multiple audio languages).
4. **Numeric buttons** -Select numbers by pressing these buttons.
5. **+10 button** -Select numbers greater than 9 by pressing the (+10) button first, and then an additional numeric button. For example, for chapter 47, press the (+10) button four times and then press the 7 button.
6. **Menu** -Press to display the disc menu on the TV screen in Play mode.
7. **Navigation buttons** (◀/▶/▲/▼/ENTER) -Use to select menu items or settings.
8. **Setup** -Press to access the DVD player's setup menu.
9. **Pause/Step** -Press to pause playback or step frame by frame.
10. **Reverse** -Press to search backward.
11. **Forward** -Press to search forward.
12. **Program** -Allows you to play the disc in a programmed sequence.
13. **Slow** -Press to activate slow forward or slow rewind.
14. **Display** -Press to show the elapsed playback time or the track number. Press to cancel onscreen text.
15. **Eject** -Press to open or close the disc tray.
16. **Subtitle On/Off** -Press to turn subtitles on or off.
17. **Subtitle** -When a DVD is playing, press to select a subtitle language.
18. **Search** -Allows you to select the desired disc starting time, track or title.
19. **Title** -Press to display titles if present on the disc.
20. **Zoom** -When a DVD is playing, press this button to activate zoom.
21. **Stop** -Press to stop playback.
22. **Play** -Press to begin playback.
23. **Next Skip/Scan** -Press to skip to the next chapter.
24. **Previous Skip/Scan** -Press to skip to the previous chapter.
25. **Repeat** -Press to repeat a chapter, track, title, or all content.
26. **A-B Repeat** -Press to mark a segment to repeat between A and B.
27. **Volume Up/Down** -Press to raise or lower the DVD volume level slightly. The volume range is smaller compared to your TV's range.

Connections

- Do not connect the power cord until all other connections have been made.
- Do not block the ventilation holes of any equipment, and arrange them so that air can circulate freely.
- Audio connections: there are stereo audio, coaxial and component digital audio outputs.
- Video connections: there are Video and S-Video outputs.
- Ensure that you observe the color-coding when connecting audio and video cables.

Connecting To a TV

- Make one of the following connections, depending on the capabilities of your existing equipment:

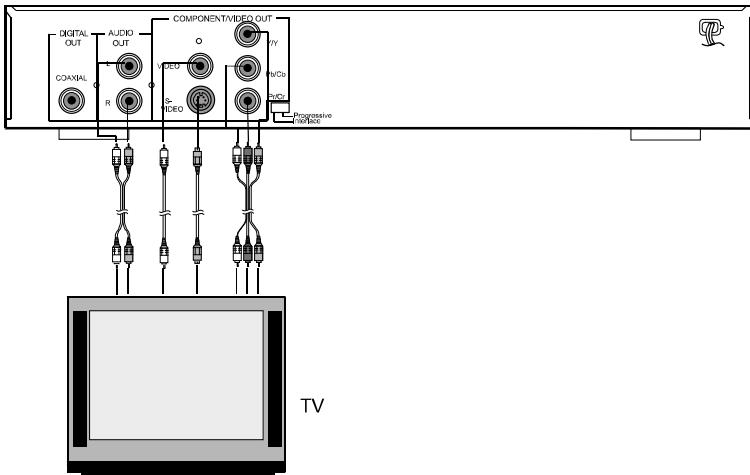

Composite Video

1. Connect the VIDEO OUT jack on the DVD Player to the video input jack on the TV using the video cable supplied.
2. Connect the Left and Right AUDIO OUT jacks of the DVD Player to the audio left/right input jacks on the TV using the supplied audio cables.

S-Video connection

1. Connect the S-VIDEO OUT jack on the DVD Player to the S-Video input jack on the TV using a S-Video cable (not supplied).
2. Connect the Left and Right AUDIO OUT jacks of the DVD Player to the audio left/right input jacks on the TV using the supplied audio cables.

Connections

NOTE: We suggest using S-Video for higher quality pictures, you may also use the standard composite video connection if your TV does not have an S-Video input.

Component Video connection

1. Connect the COMPONENT VIDEO OUT jacks on the DVD Player to the corresponding input jacks on the TV using a Y/Pb(Cb)/Pr(Cr) cable supplied.
2. Connect the Left and Right AUDIO OUT jacks of the DVD Player to the audio left/right input jacks on the TV using the supplied audio cable.

Connecting To an Analog Amplifier

Connect the Left and Right AUDIO OUT jacks on the DVD Player to the audio left and right input jacks on your amplifier, receiver or stereo system using the supplied audio cable. The connection diagram is shown as below:

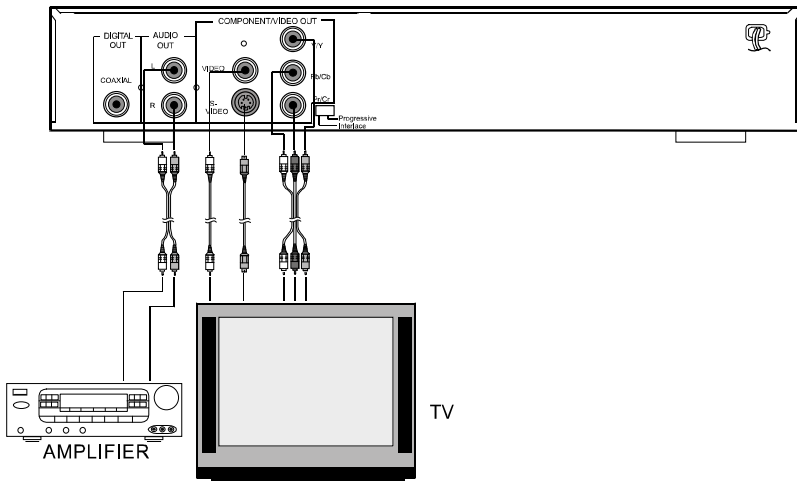

IMPORTANT: If the video has component video inputs, connect the component video outputs on the DVD Player to the corresponding input jacks on your television. If you are using a Progressive Scan television or projector, you must also change the DVD Player's video mode by shifting the switch from "Interlace" to "Progressive" on the rear panel.

Connections

Connecting To an Amplifier With Dolby Digital or DTS Decoder

Connect the DVD Player's DIGITAL AUDIO OUT jack (coaxial) to the corresponding input jack on your amplifier with a digital (coaxial) audio cable (not supplied).

When DVDs encoded in Dolby Digital or DTS are played, the Dolby Digital or DTS bit stream is outputted from the player's coaxial digital audio output. When the DVD player is connected to a Dolby Digital or DTS decoder, you can enjoy theater quality audio in your home. A coaxial audio cable is required for these connections, as shown below.

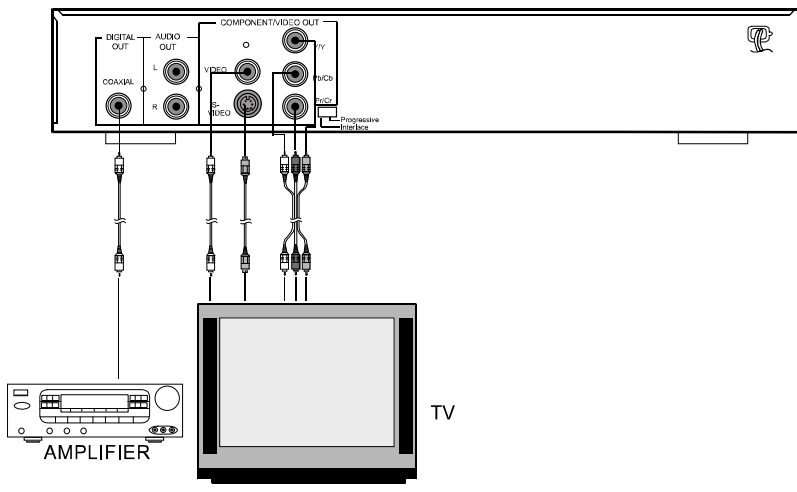

NOTE: If the amplifier has Dolby AC-3 decoding function, set the output format of digital audio signal in setup menu to "SPDIF/RAW".

Remote Control Operation

Battery Installation

Insert the batteries supplied while observing the correct (+) and (-) polarities.

Service life of Batteries

- The batteries normally last for about six months, although this depends on how often, and for what operations, the remote control is used.
- If the remote control unit fails to work even when it is operated near the player, replace the batteries.
- Use fresh "AAA" batteries.

NOTES:

- Do not attempt to recharge, short-circuit, disassemble or heat batteries; do not throw them into fire.
- Do not drop, step on or otherwise batter the remote control unit. This may damage the parts or lead to a malfunction.
- Do not mix old and new batteries.
- Wipe away any leakage inside the remote control unit, and install new batteries.
- If leakage should come into contact with your skin, immediately wash it off thoroughly with water.
- Batteries contain chemical substances and we recommend that you dispose of them properly and in compliance with any local regulations.

Remote Control Operation Range

Point the remote control unit from no more than about 23 feet from the remote sensor and within about 60 degrees of the front of the unit.

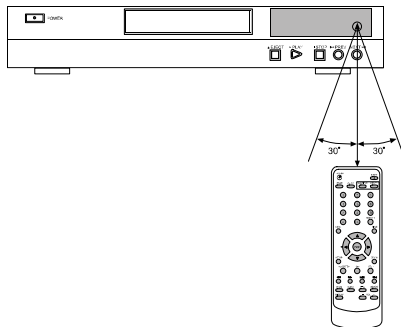

- The operating distance may vary according to the brightness of the room.

NOTES:

- Do not point bright lights at the remote control sensor.
- Do not place objects between the remote control unit and the remote control sensor.
- Do not use this remote control unit while simultaneously operating the remote control unit of any other equipment.

System Setup

System Defaults

The final step of the installation is to establish the system's defaults. It is helpful to take a few minutes to familiarize yourself with these settings, as they may require change before the first use and later from time to time.

Setup Menu

The first step in checking or changing the system defaults is to access the Setup menu. First, make certain that the DVD Player is properly connected. Turn the DVD Player on by first pressing the POWER button. For this process, however, you do not need to load a disc into the unit.

During Stop, Pause or Play mode, if you press the Setup button on the remote, the Setup menu appears on the screen.

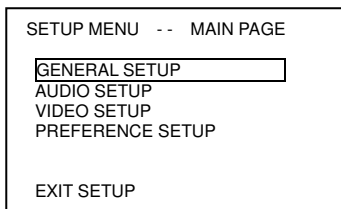

Navigating Menus

The remote's Navigation (▲/▼/▶/◀) and ENTER buttons are used to navigate the menus and select specific settings. Use the (▲/▼) buttons to move the cursor to highlight the desired submenu, then press the ▶ button to enter the highlighted menu or

choose the highlighted content. The current setting is highlighted.

If you wish to change this setting, use the (▲/▼) buttons to select a new setting and press the Enter button. Press the ◀ Navigation button to return to the left submenu column. Press the Play button or Setup button to exit the Setup menu.

Any new settings will be activated immediately.

After you press the SETUP button on the remote to enter the Setup menu, five submenus are shown: General setup, Audio setup, Video setup, and Preference setup. You may select EXIT SETUP with the Navigation buttons and press the ENTER button at any time to leave the Setup menu.

System Setup

General Setup

When you enter the Setup menu, use the (▲/▼) buttons to highlight the General Setup, then press the ► button to access the General Setup. The left column shows the items in the General Setup. The right column shows the current setting for each item.

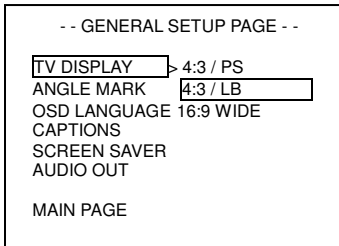

TV Display

Select TV DISPLAY with the ▲/▼ Navigation buttons, if it is not already selected; then press the ► Navigation button to access the TV Display submenu. The right column displays the current setting (highlighted) and two options. If needed, select a new setting. Press the ENTER button to confirm the new setting. This menu selects the TV Display: conventional screen shape (4:3) or wide screen (16:9), according to your TV.

Angle mark

Select the Angle Mark menu by pressing the (▲/▼) Navigation buttons until ANGLE MARK is highlighted and then press the ► button to access the submenu. This setting allows you to select "ON" or "OFF".

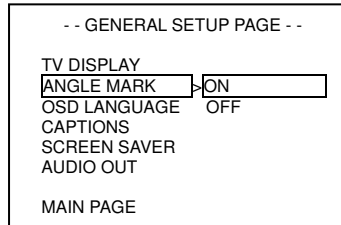

NOTE: Some chapters in some DVD discs include many different angles. If the angle mark is set to be "ON", then there will be a multi-angle mark displaying on the screen when playing the contents with multi-angle. Here, you can use ANGLE button to enjoy different angles. If the angle mark is set to be "OFF", then there will be no angle mark on the screen.

OSD Language

Select the OSD Language menu by pressing the (▲/▼) Navigation buttons until OSD LANGUAGE is highlighted and then press the ► button to access the submenu. The right column displays the current setting (highlighted) and the options.

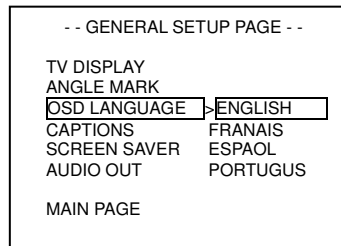

NOTE: OSD stands for "ON SCREEN DISPLAY". You can

select your language preference.

System Setup

Captions

Select the Captions menu by pressing the (▲/▼) Navigation buttons until CAPTIONS is highlighted and then press the ► button to access the submenu. This setting allows you to select "ON" or "OFF".

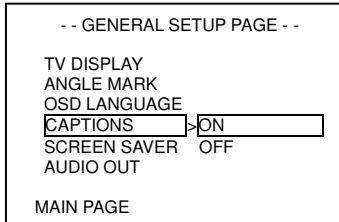

NOTE: Some DVD discs have hidden captions. You can turn the hidden captions on or off with this setting.

Screen Saver

Select the Screen Saver menu by pressing the (▲/▼) Navigation buttons until SCREEN SAVER is highlighted and then press the ► button to access the submenu. This setting allows you to select "ON" or "OFF".

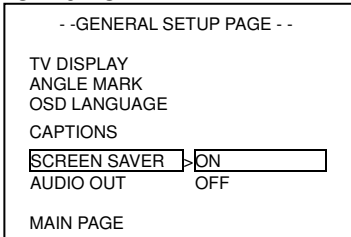

NOTE: Select "ON" to activate the screen saver after an idle period. During this time, there will be a moving symbol on the screen; select "OFF" to turn off this

function.

Audio Out

Select the Audio out menu by pressing the (▲/▼) Navigation buttons until AUDIO OUT is highlighted and then press the ► button to access the submenu. This setting allows you to select "SPDIF OFF" or "SPDIF / RAW".

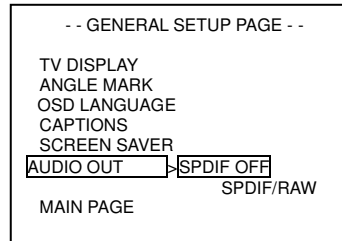

NOTE: This item is used to set the format of digital audio. "SPDIF OFF" turns off the digital audio; "SPDIF/RAW" outputs the original. For example, if the disc being played is Dolby AC-3, then the digital audio output is also Dolby AC-3.

System Setup

Audio Setup

In the Setup menu, use the (▲/▼) Navigation buttons to highlight the Audio Setup; press the ENTER button to access the Audio submenu. The left column shows the items in the Audio Setup menu. The right column shows the current setting for each item.

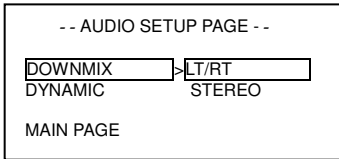

Downmix

Select "LT/RT" to have the player output mixed audio as prescribed by the Dolby standard. Select "STEREO" to have the player output common stereo.

Dynamic

Select the Dynamic menu with the (▲/▼) Navigation buttons, if it is not already highlighted; press the ► button to access the Dynamic submenu.

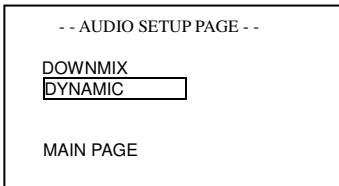

The Dynamic Range Compression can be turned off by selecting "OFF" from the submenu, or set to full compression by selecting "FULL". There are also intermediate levels of compression available for selection.

This setting enables Dolby Digital recordings to be played back with full dialog volume while reducing peak volume levels. This smooth level compression prevents abrupt volume transitions without reducing the impact of the digital source.

Video Setup

In the Setup menu, use the (▲/▼) Navigation buttons to highlight the Video Setup; press the ENTER button to access the Video submenu. The left column shows the items in the Speaker Setup menu. The right column shows the current setting for each item

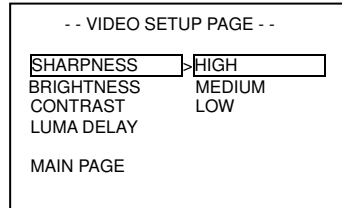

NOTE: You can adjust the above parameters to suit your preference.

Preference Setup

To enter the Setup menu, use the (▲/▼) buttons to highlight the Preference menu, and then press the ENTER button to access the Preference Menu. The left column shows the items in the Preference Menu. The right column shows the current setting for each item.

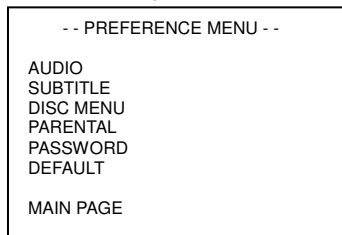

System Setup

Audio

Select AUDIO with the (▲/▼) buttons, if it is not already selected; press the ► button to access the Audio submenu. The right column displays the current setting (highlighted) and the options. Press the ENTER button to choose your favorite audio language.

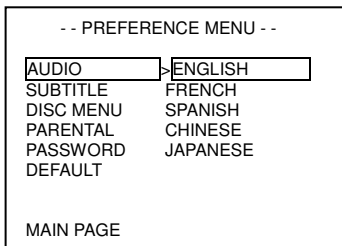

This option will define the default audio language (if the disc contains different language tracks). The option default will select the audio language originally encoded as the default language on the disc; often this will be English. Choosing an audio language by pressing the AUDIO button on the remote control will change this setting only temporarily.

Subtitle

The Subtitle Language menu allows you to select the language that will be used to display the subtitles that accompany the DVD's audio track. Note that although this menu permits you to select a language, in order for that language to appear it must be present on the disc. Before making a change to this menu, consult the DVD jacket for information on the subtitle languages available for any particular disc. If your menu choice is English, no change to the default setting is needed, in which case

you may press the ▼ button proceed to the next setting.

To change the setting, make certain that the SUBTITLE line is highlighted and press the ► button. The right side of the screen will then display the available options and the current Subtitle Language setting will be highlighted.

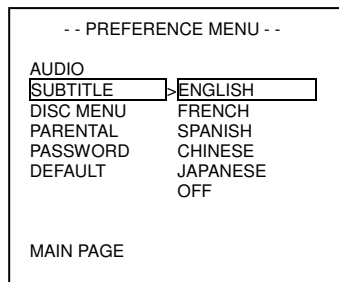

With this setting you define your preferred subtitle language (if the disc contains different subtitles). You may also change the subtitle language at any time when the disc is playing by pressing the SUBTITLE button on the remote control. Changes made with the SUBTITLE button are temporary and will only remain in effect during the playback of a specific disc. The changes made in this menu will become the unit's default setting.

This setting can turn subtitles on or off. If set to OFF, subtitles will not be displayed automatically.

You can also use the SUBTITLE ON/OFF button on the remote control to turn subtitles on or off. The SUBTITLE button on the remote control can be used to change subtitles during playback. When the selection process is complete, press ◀ button to continue with the selection options for other features.

System Setup

Disc Menu

Select the Disc menu by pressing the (▲/▼) Navigation buttons until DISC MENU is highlighted and then press the ► button to access the submenu. This setting allows you to select the language.

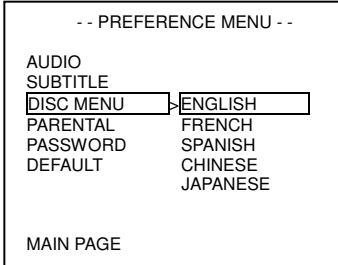

NOTE: There are several multi-language menus for some discs. If there is no specific default on the disc, then the set menu language will have the priority to be played first.

Parental

Select the Parental menus by pressing the (▲/▼) Navigation buttons until PARENTAL is highlighted and then press the ► button to access the ratings list.

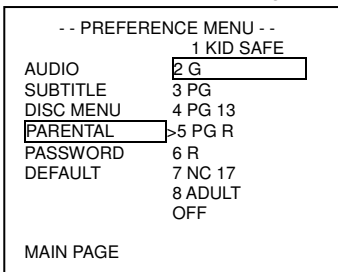

Press the (▲/▼) Navigation

buttons to select the desired ratings control level. **NOTE:** The lower the number, the higher the restriction. When the level you prefer is highlighted, press the ENTER button to activate it.

Password

Select the Password menu by pressing the (▲/▼) Navigation buttons until PASSWORD is highlighted and then the ► button to access the submenu. This setting allows you to change the password.

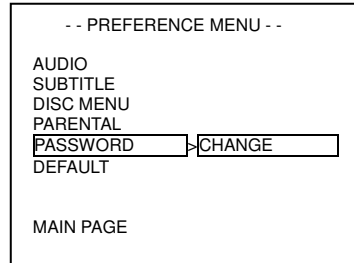

Press the ENTER button to access the Password change menu. Enter the old four-digit password in the OLD PASSWORD field (initial factory default password is 1369). When the correct password is entered, the cursor will move to the NEW PASSWORD field. Enter a new four-digit password. The cursor will move to the CONFIRM PASSWORD field. Enter the new password again to confirm. If the new password is confirmed, the display will indicate "Press ENTER TO CONTINUE". Press the ENTER button to confirm and exit the Password change submenu.

System Setup

Default

Select the Default menu by pressing the (▲/▼) Navigation buttons until DEFAULT is highlighted and then press the ► button to access the submenu.

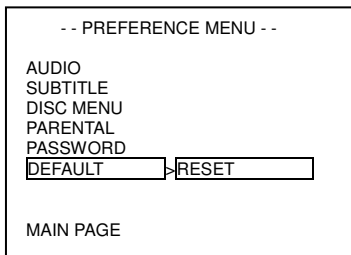

To reset the unit to the original defaults, press the ENTER button to confirm. Otherwise, press the ◀ button to exit the submenu and leave all settings intact.

Normal Operation

Preparation: After connections have been made, turn on the TV and select the relevant video input before playback.

1. Turn on the player's power

Press the POWER button on front panel to turn on the power and the player will search for the disc automatically. If there is a disc in, the player will automatically play it.

3. Load the disc

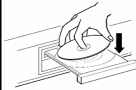

Load the disc as shown in the figure in order not to damage the player or the disc.

2. Press the EJECT button on front panel or on remote control to open the disc tray.

4. Press the EJECT button to close the disc tray and begin playback.

Warning: Do not play poor quality discs which may damage the lens.

DVD Playback

MENU

Normally there is a selecting menu on DVD disc. You can press the MENU button to enter the disc menu directly, then use the direction buttons to highlight the item you would like. Press the ENTER button to select it.

TITLE & CHAPTER

Normally there are several titles on a DVD disc, and also there are several chapters in a title. You can select any one of titles or chapters quickly by using the Numeric buttons to enter the number of the chapter.

REGION CODE

This DVD player plays Region 1 DVD discs.

Normal Operation

LANGUAGE (AUDIO)

There are up to 8 kinds of languages on a DVD disc. When you play a multi-language DVD disc, press the AUDIO button on remote control to select language.



SUBTITLE

The DVD player can support up to 32 kinds of subtitles. When you play a multi-subtitle disc, press the SUBTITLE button on remote control to select subtitle.

ANGLE

The DVD player supports multi-angle function. Multi-angle means that a scene is shot from different angles so that audience can watch from any angle. If the disc you are watching contains multiple angles, you can use the ANGLE button to select the angle you would wish to view. Press the ANGLE button continuously to view different angles.

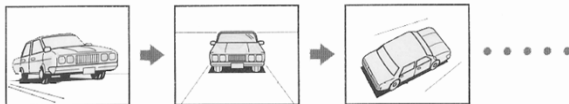

VOLUME

During playback, press the VOL+ button to increase the volume and press the VOL- button to decrease the volume.

Normal Operation

CD Playback

The player will play all tracks continuously in default status. You can press the ◀◀ and ▶▶ (PREV/NEXT SKIP) buttons or Numeric buttons to select the track or your choice.

MP3 Playback

MP3 is the third audio compression format of the international standard MPEG. It compresses the audio file size by 12:1. One disc can record more than 600 minutes of music with sound quality similar to that of CD discs.

Programming a play list

Load a MP3 disc. After the disc has been read, "SMART NAVI" will be displayed on the screen. The screen is divided into three columns: Root (upper left), Subdirectory (upper right) and Play Mode (lower). You can use the Left/Right direction buttons to shift between them.

1. When playback is stopped, press the (◀/▶) buttons to move the cursor to the "PLAY MODE" column. Use the (▲/▼) buttons to select the play mode. Press the (◀/▶) buttons to confirm. You can also use the PROGRAM or REPEAT buttons on the remote control to select the play mode. Press the (◀/▶) buttons to move the cursor to the Subdirectory column, and use the (▲/▼) buttons or Numeric buttons to select a MP3 folder. Press the ENTER button to confirm. Press the (▲/▼) buttons or Numeric Buttons to select the track you like and press the ENTER Button to confirm.

2. Press the ◀◀ and ▶▶ (PREV/NEXT SKIP) buttons to select the previous/next track in the same folder.

3. Press the STOP button and then use the Navigation buttons to return to the previous menu level.

4. When all track selection is finished, first press the STOP button to end play list programming, and then press the PLAY button to start playback.

◆ There is no search by time and slow playback function for MP3 discs.

Normal Operation

JPEG Playback

JPEG is a common picture format that requires few bytes of storage per image low loss rate in resolution. Hundreds of pictures can be stored on a disc in this format. In order to view digital albums, use your film development to make a "PICTURE CD", in JPEG format.

OPERATION

1. Normal Playback

Load a JPEG disc. After reading the disc, "SMART NAVI" and "ROOT" will be displayed on the screen (the left is the menu of last level and the right is the menu of next level). Use the ENTER button and the (◀/▶) buttons to select a submenu with pictures. Use the (▲/▼) buttons to select the contents in the menu.

- ◆ Many discs have other contents besides pictures.

- ◆ Use the (◀/▶) buttons to move the cursor to the "PLAY MODE" column, and use the (▲/▼) buttons to select "PLAY MODE".

For example: Select "FOLDER" in "PLAY MODE", and then use Navigation buttons to select the name of the picture file, and then press ENTER button to confirm.

- ◆ Use the PREV/NEXT SKIP buttons to select the previous or next part of a picture.

2. Picture Rotation

This can be used when the picture is displayed. Once another picture is selected, rotation will be cancelled automatically.

There are four kinds of rotational modes: Inversion, Enantiomorphism, Rotate left and rotate right. You can use direction buttons to select:

"UP" ----- Inversion/Normal

"DOWN" ----- Enantiomorphism/Normal

"LEFT" ----- Rotate left.

"RIGHT" ----- Rotate right.

3. Zoom of Picture

ZOOM button is used to turn on/off the zoom and the move function.

When this function is turned on, use REV/FWD SCAN buttons to control the zoom and the TV screen will display the relevant proportion. Then you can use Navigation buttons to move the picture.

When this function is turned off, the picture will resume its normal size.

- ◆ Depending on how the disc was made, a JPEG disc may allow playback, but not rotation or zooming of the images.

Playback Functions

STOP

When you press the STOP button in DVD playback, playback will stop, but you can resume playback from the same point by pressing the PLAY button (for DVD discs). Press the STOP button twice to stop playback completely and return to the beginning of the disc.

PAUSE

Press the PAUSE/STEP button on remote control to pause, and press it repeatedly to achieve frame-by-frame playback.

REPEAT

1. Use the REPEAT button to repeat a chapter (section), a title, a track or a disc, and also to cancel repeat.
2. Use the A-B button to repeat a section A to B. Press it once to set the starting point A, then a second to set the ending point B, and the third time to cancel repeat.

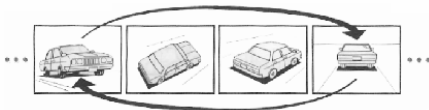

◆ Some discs do not support the repeat function.

SEARCH BY TIME

You can use the SEARCH button to search by time, namely to play from a specific time.

Press the SEARCH button once to display the title or chapter for DVD discs, and use Numeric buttons or Navigation buttons to select any one of them. Press the SEARCH button twice then you use the Numeric buttons to input the time (hour, minute, and second). Press the ENTER button and the player will from the inputted time.

Press the SEARCH button to input the time for CD discs and the player will play from the input time.

- ◆ Some DVD discs do not support search function.

Playback Functions

FAST FORWARD & REWIND

Press the ◀ and ▶ (REV/FWD SCAN) buttons to activate fast forward or rewind.

SLOW FORWARD & REWIND

Press the SLOW button to activate slow forward or rewind.

- ◆ There is no slow playback function for CD and MP3 discs.

DISC INFORMATION DISPLAY

Press the DISPLAY button on the remote control to display relevant disc information.

PLAY

Press the PLAY button to start playback. Press the POWER button on the remote control to enter standby mode, and press it again to resume playback status.

PROGRAM PLAYBACK

Use the PROGRAM button to activate program playback of DVD and CD discs.

Operation steps:

1. In stop status, press the PROGRAM button to enter program status.
2. Use the Numeric buttons to input contents according to prompts.
3. Repeat step 2 to program more contents.
4. Use the Navigation buttons to move cursor to "START" and then press the ENTER button or the PLAY button to begin the program playback.

ZOOM FUNCTION

Use the ZOOM button on remote control to activate zoom.

Press the ZOOM button to achieve desired zoom:

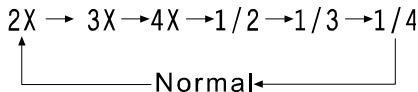

- ◆ There is no zoom function for CD and MP3 discs.
- ◆ While zooming, the picture may look coarse.

Troubleshooting

SYMPTOM	CHECK ITEM
The player will not play or displays "NO DISC".	<ul style="list-style-type: none"> -If disc is loaded in. -If disc is loaded upside down. -If disc is dirty or warped. -If the players region code is the same as the region code of DVD disc. -If water condensation has occurred. -If it occurs, take out disc and leave the player on for at least one hour.
There is no sound.	<ul style="list-style-type: none"> -If system connection is correct. -If the power to speakers is turned on. -If the sound setup of DVD disc is correct. -If disc is dirty or warped. -If it occurs, clean it or press it.
There is no picture.	<ul style="list-style-type: none"> -If TV is turned on and is in correct video mode. -If system connection is correct.
Picture move up and down. Unsteady.	<ul style="list-style-type: none"> -If the signal system is correct.
Cannot continue to play and play a section repeatedly.	<ul style="list-style-type: none"> -If it is in A-B repeat status. -If it is true, press A-B button to cancel it. -If disc is dirty or damaged. -If it is true, clean it or skip the section.
The remote control does not work.	<ul style="list-style-type: none"> -If there are obstructions between the remote control and the player. -If you are pointing the remote control at the player. -If batteries are inserted or the polarity is correct. -If batteries are weak. -If it is true, replace them.

Others:

Static or other external interfere may cause the abnormality of the player. In this circumstance, unplug the power-supply cord from the outlet. Wait 10 seconds and plug it in again to reset the player so that the normal operation will be resumed. If you are still having problems, then please disconnect the

power and consult your service center or a qualified technician.

Specifications

Laser Wavelength		Wavelength: 780/650nm
Video System		NTSC
Frequency Response		20Hz~20KHz ±2.5dB
Audio Signal-to-noise Rate		≥85dB
Audio distortion + noise		≤-70dB (1KHz)
Channel Separation		≥70dB (1KHz)
Dynamic Range		≥80dB (1KHz)
Audio Out	Analog Audio Out	Out Level: $2V \pm_{1.0}^{0.2}$, Load: 10K Ω
	Digital Audio Out	Out Level: 0.5V _{P-P} , Load: 75 Ω
Video Out	Video Out	Out Level: 1V _{P-P} ± 0.2, Load: 75 Ω Unbalanced Negative
	S-Video Out	Out Level: Y: 1V _{P-P} , C: 0.286V _{P-P} Load: 75 Ω
Power		AC120V~ 60Hz
Power Consumption		25W
Dimension		2.6" (H) × 16.9"(W) × 10.7"(D)
Weight		6.6 lbs

DESIGN AND SPECIFICATIONS ARE SUBJECT TO CHANGE WITHOUT NOTICE.

Manufactured under license from Dolby Laboratories.
 "Dolby" and the double-D symbol are trademarks of
 Dolby Laboratories. Confidential unpublished works.
 ©1992 -1997 Dolby Laboratories. All rights reserved.